

kreator

hybrid additive manufacturing and milling system

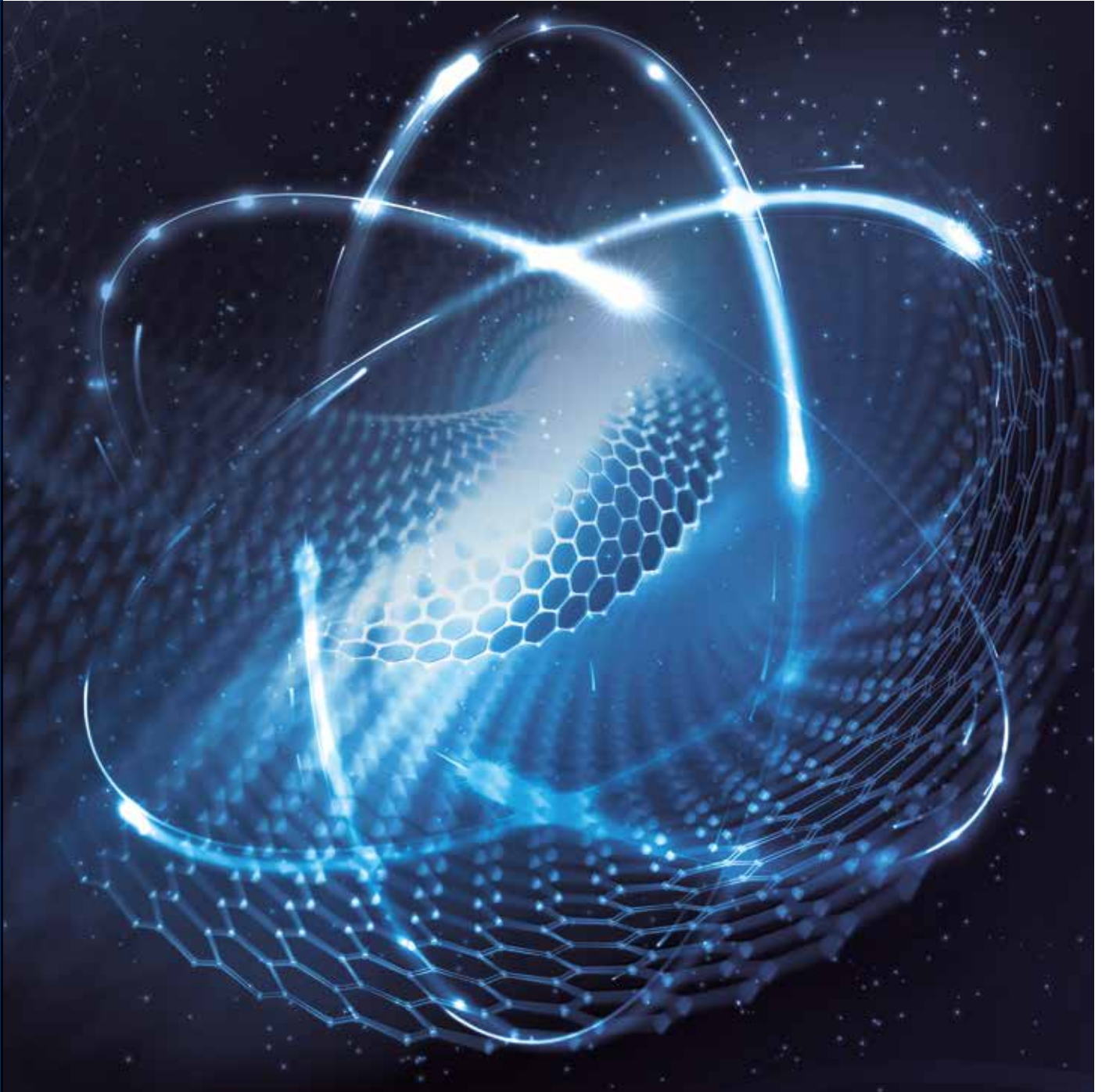

CMS is part of SCM Group, a technological world leader in processing a wide range of materials: wood, plastic, glass, stone, metal, and composites. The Group companies, operating throughout the world, are reliable partners of leading manufacturing industries in various market sectors, including the furniture, construction, automotive, aerospace, ship-building, and plastic processing industries. SCM Group coordinates, supports, and develops a system of industrial excellence in three large, highly specialized production centers employing more than 4,000 workers and operating in five continents. SCM Group: the most advanced skills and know-how in the fields of industrial machinery and components.

CMS SpA manufactures machinery and systems for the machining of composite materials, carbon fiber, aluminum, light alloys, plastic, glass, stone, and metals. It was established in 1969 by Mr Pietro Aceti with a vision of offering customized and state-of-the-art solutions, based on the in-depth understanding of the customer's production needs. Significant technological innovations, originating from substantial investments in research and development and take-overs of premium companies, have enabled constant growth in the various sectors of reference.



CMS Advanced Materials Technology is a leader in the field of numerically controlled machining centers for the working of advanced materials: composites, carbon fiber, aluminum, and light alloys. Substantial investments in research and development have allowed the brand to always be on the forefront of cutting-edge design, with machines that ensure best-in-class performance in terms of accuracy, speed of execution, and reliability; meeting the needs of customers operating in the most demanding divisions.

Since the early 2000's, **CMS Advanced Materials Technology** has established itself as a technology partner in areas of excellence such as aerospace, aviation, automotive, race boating, Formula 1, and the most advanced railway industry.



kreator

APPLICATIONS	6-7
CMS KREATOR: STRONG REASONS WHY	8-9
KREATOR ARES	10-11
KREATOR ARES TECHNOLOGICAL DETAILS	12-13
KREATOR ARES OVERALL DIMENSIONS & TECHNICAL DATA	14-15
DIGITAL SERVICES	16-17
SERVICE	18-19
THE RANGE	20-21
THE SCM GROUP	22-23

MAKING ADDITIVE REAL REAL



APPLICATIONS



tooling for composites



epoxy ureol or similar replacement



Revolutionary.
Efficient.
Accurate.
Largely sustainable.

Making Additive REAL.

Hybrid additive manufacturing and milling system

CMS KREATOR

CMS, leader in cnc machines for composite processing, started in 2018, in cooperation with the prestigious Fraunhofer institute, to develop an original LFAM (LARGE FORMAT ADDITIVE MANUFACTURING) solution, for improving the competitiveness of composite and other industries.



The hybrid system has been developed in partnership with the prestigious Fraunhofer Institute for Machine Tools and Forming Technology in Germany.



PRINTING

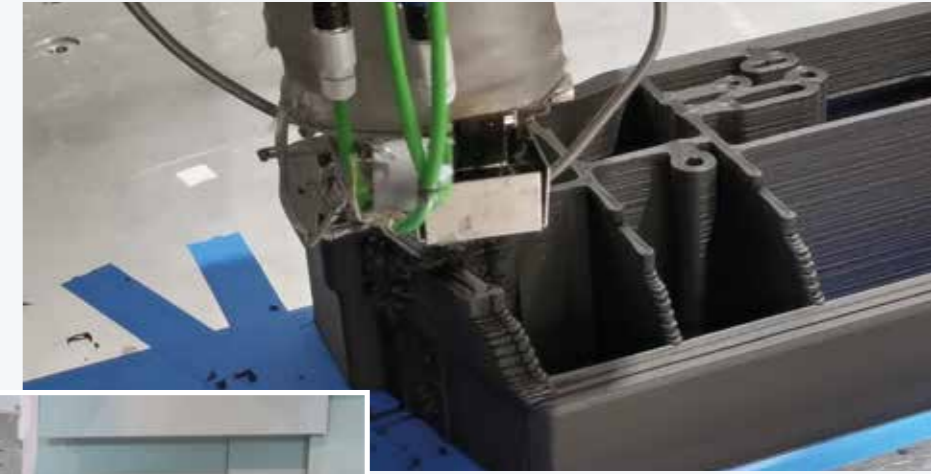

MILLING

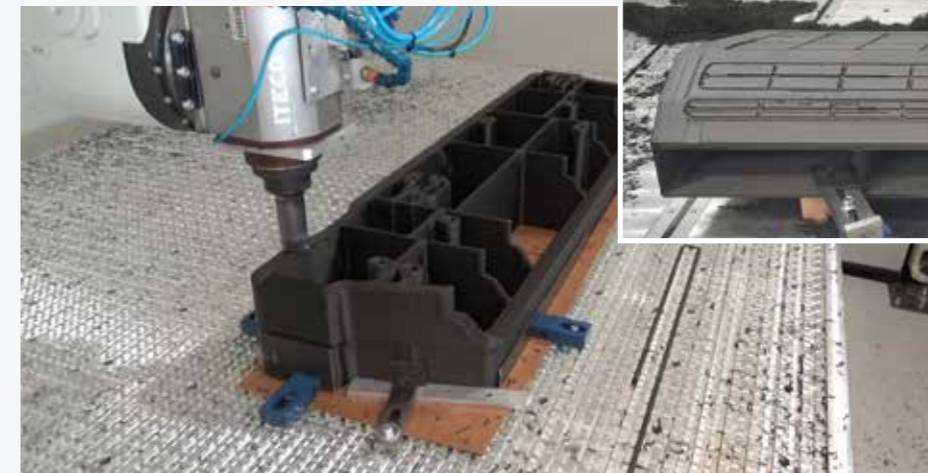

EXTRUDER FOR AUTOMATIC CONNECTION

- 3d printing device fully integrated in a standard CMS machine: no manual operations needed.

LESS MATERIAL, MORE PRINTING SPEED: PRINTING SPEED UP TO 16 M/MIN

KREATOR ARES

CMS kreator takes advantage of the **CMS mechanical base**, an integrated machining center for vertical milling **ideal for composite materials, aluminum, light alloys and metals processing**. The advanced design of its structures and the result of CMS's continuous investments in R&D with the sophisticated technological solutions adopted, provides **rigidity and precision, and exceptional movement dynamics**.



PATENTED!

EXTRUDER

CMS kreator's single screw extruder is **patented, designed for 3D printing and for the use of different materials**.

- **The CMS kreator technology allows for 45° and 90° printing**
- **Mass Flow = 1 ÷ 10 Kg/h**

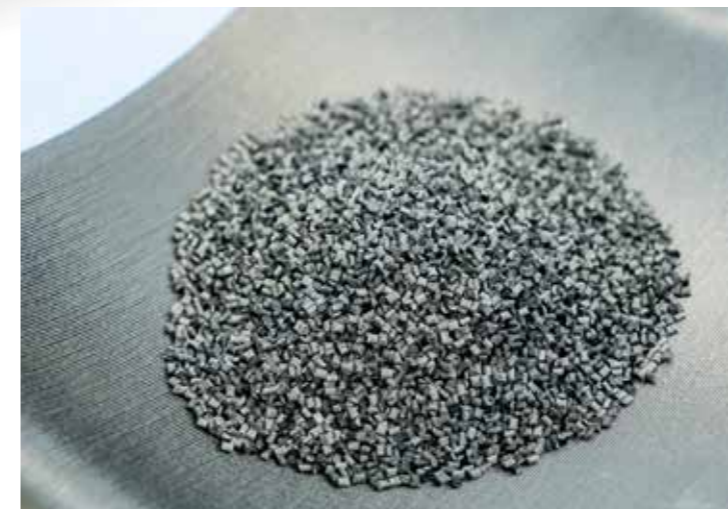

MATERIAL

The R&D department tested the extruder with **PLA, PP, PET, PA, ABS, PC, PEI, PESU** and others, **reinforced with carbon or glass fiber**.

CMS is open to test other materials requested by customers at **CMS KREATOR ADDITIVE LAB**

KREATOR ARES

TECHNOLOGICAL DETAILS

KEY BUYERS BENEFITS

- + **HIGHLY FLEXIBLE:** CMS Kreator incorporates technology that allows it to **print at 0°, 45° and 90°**. This machine can use a range of material types: **PLA, PP, PET, PA, ABS, PC, PEI, PESU and many others**.
- + **MATERIAL SAVING:** At least **81% material saving** for manufacturing a part, compared to **current manufacturing technologies and competitors**.
- + **SUSTAINABLE SOLUTION:** Printing speed up to **16 m/min**, faster than large sized FDM and competitors.
- + **New slicing software** developed exclusively for CMS simplifies the process and temperature control, thereby reducing printing times and improving production workflow.

DISCOVER ICARUS!



NEW!

EASE OF USE

GENERATE PRINTING PARAMETERS AUTOMATICALLY

The software analyzes the part geometry, properties of the printed strand and selected material, and automatically suggests the best printing parameters.

CREATE PROJECTS WITH SIMPLIFIED 3D MODELS

Projects can be developed and modified using elementary geometric shapes.

PRODUCT-ORIENTED SOFTWARE

CREATE PARAMETRIC MODELS

Templates can be created for various materials, printing strategies and applications.

EXCLUSIVE FEATURES

Create internal reinforcement structures, reduction zones and supports for critical areas

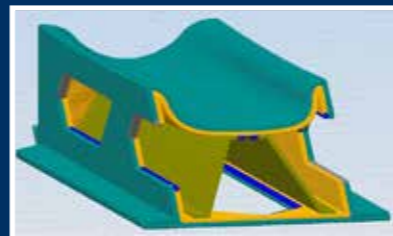

PROCESS SIMULATION

AS 3D PRINTED MODEL

Export the 3D model generated, which exactly represents the final printed result

CONTINUOUS ANALYSIS

The 3D model can be used to analyze printed thicknesses and, with the aid of specific software, perform structural analysis.

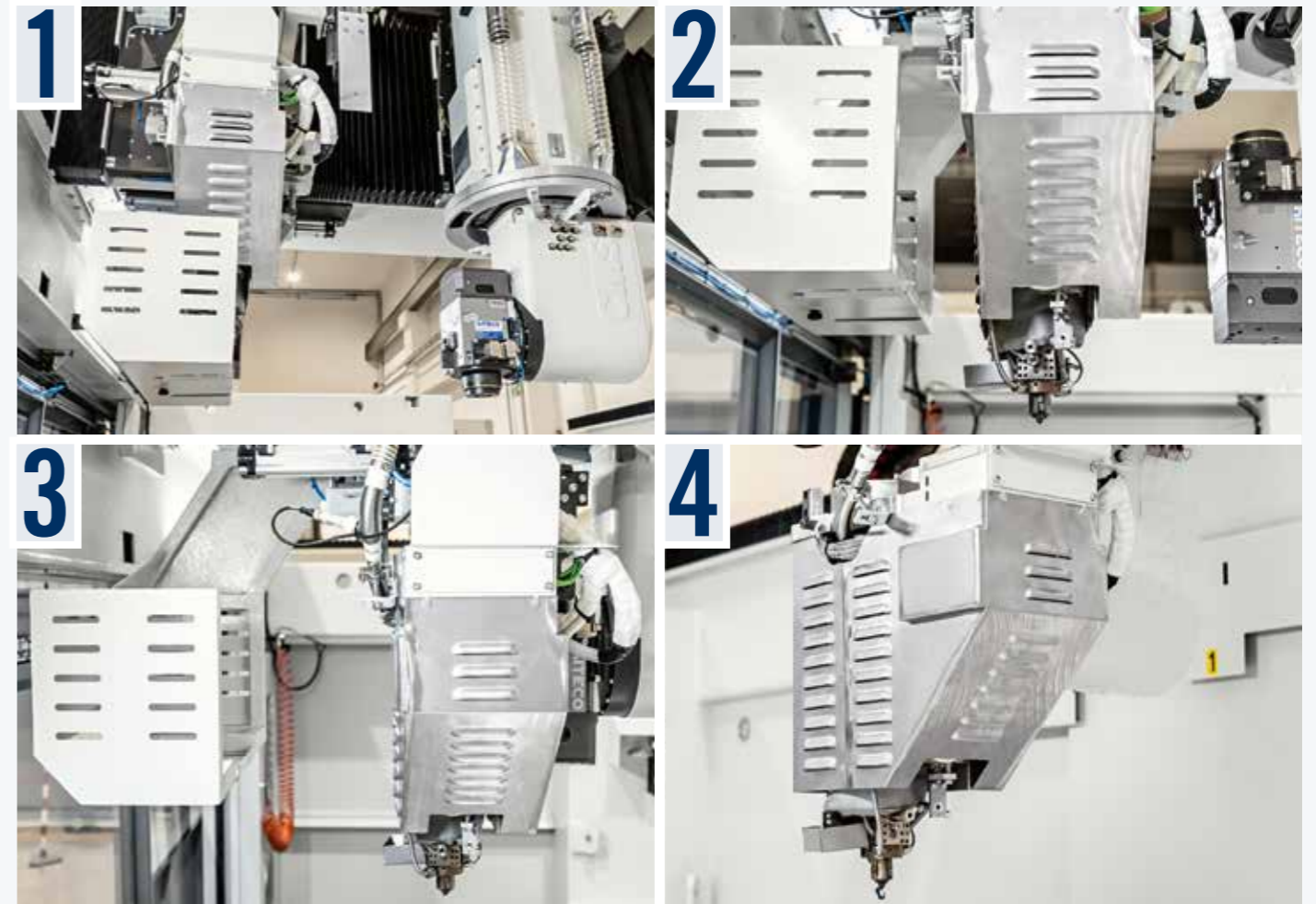

AUTOMATIC CONNECTION BETWEEN THE ELECTROSPINDLE AND THE EXTRUDER.

An **additional y-carriage** conveys the extruder with all its components and it can be hooked on to the machining unit's y-carriage. In **this way the automatic tool/extruder change is carried out without the need of connectors**.

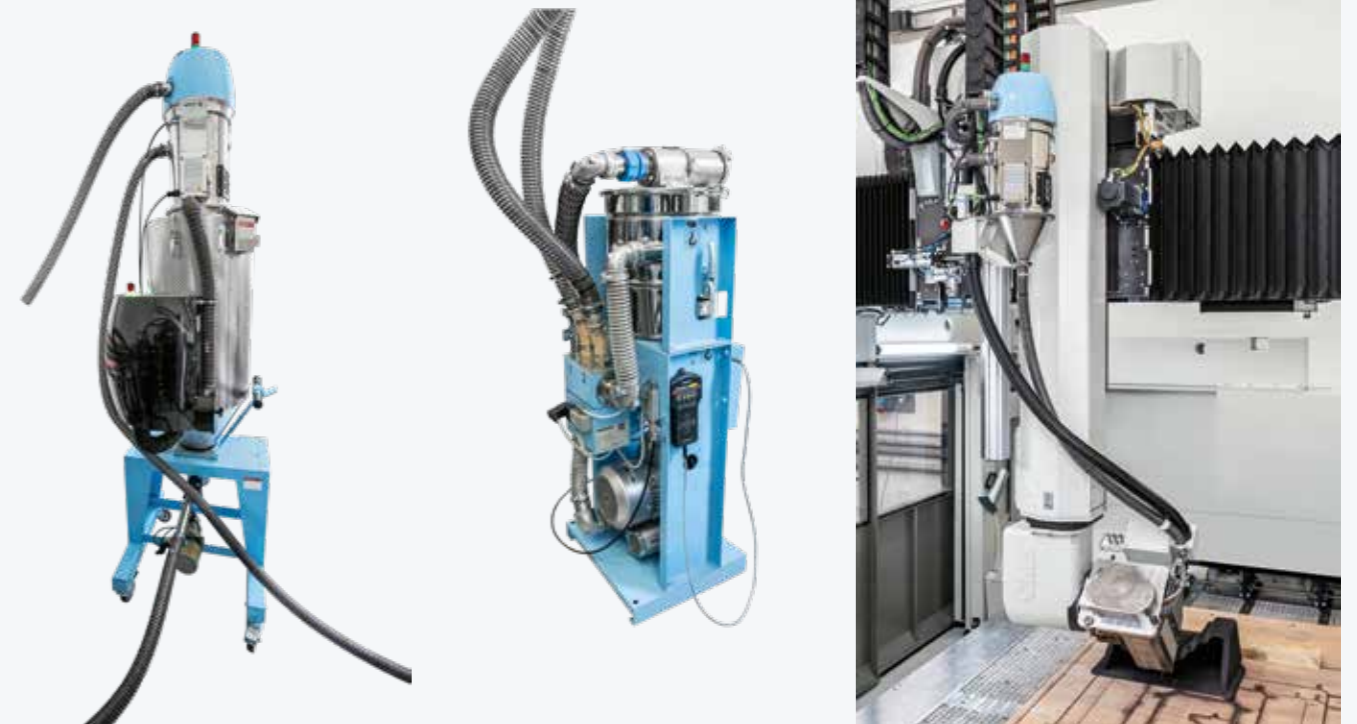

MATERIAL LOADING AND DRYING

Granulate material loading and drying system with dust filtering.

KREATOR ARES

OVERALL DIMENSIONS & TECHNICAL DATA

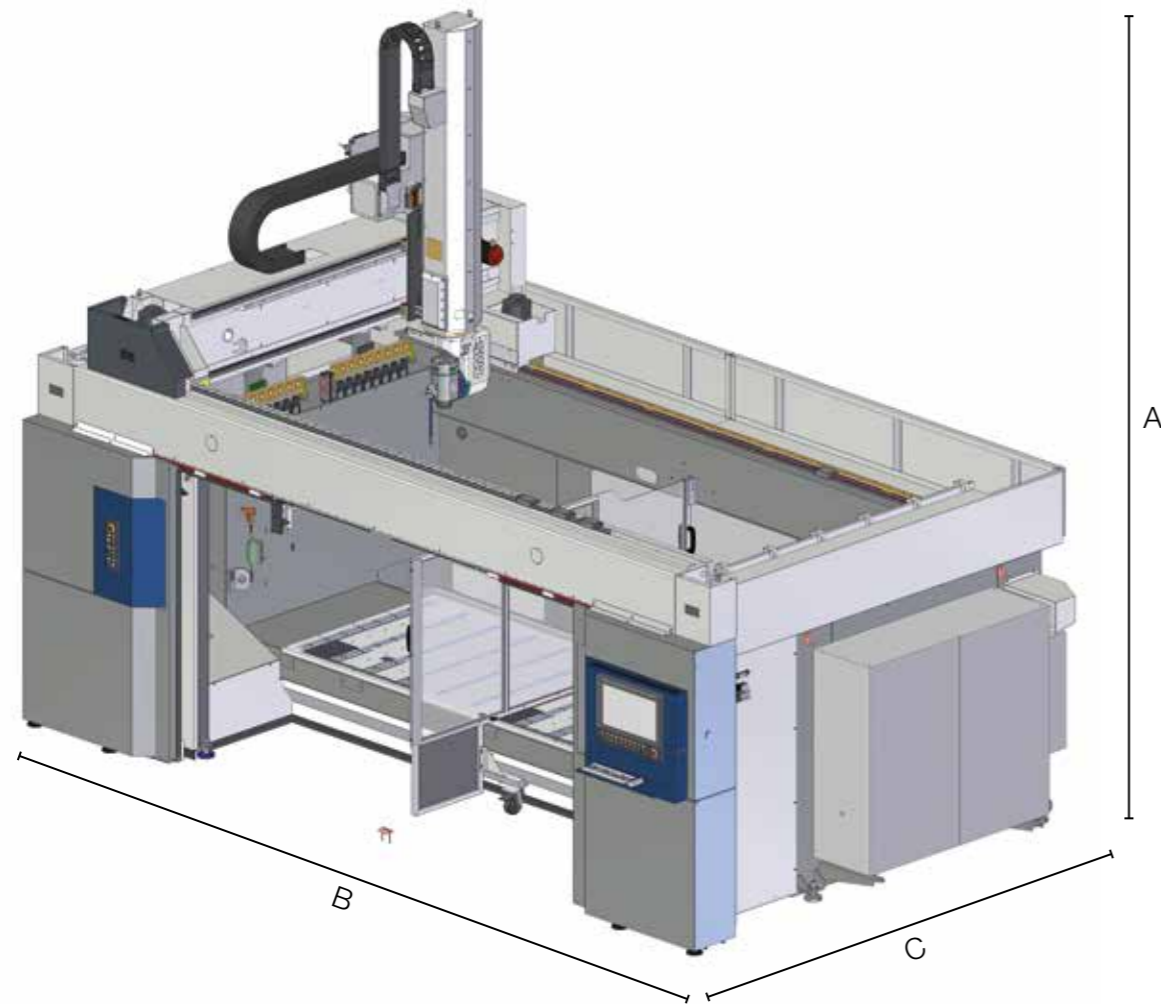

KREATOR ARES: ENCUMBRANCE (mm)		
A	Z AXIS STROKE	
	4450	
B	X AXIS STROKE	
	36/18 36/26	48/18 48/26
	6400	7810
C	Y AXIS STROKE	
	36/18 48/18	36/26 48/26
	3920	4820

KREATOR ARES: WORKING PLANE	
MODEL	DIMENSIONS X (mm)
KREATOR ARES 36/18	3640x1360
KREATOR ARES 36/26	3640x2360
KREATOR ARES 48/18	4840x1360
KREATOR ARES 48/26	4840x2360

KREATOR ARES: STROKES AND SPEEDS (MILLING)									
MODEL	AXIS STROKE					RAPIDS			
	(mm)					(°)			
	X	Y	Z	B	C	X/Y	Z	B	C
36/18	3500	1190	1200	±120	±270	80	70	9000	
48/18	4700								
36/26	3500	1990							
48/26	4700								

KREATOR ARES: STROKES AND SPEEDS (3D PRINTING - LINEAR AXIS ONLY)			
MODEL	AXIS STROKE		
	(mm)		
	X	Y	Z
36/18	3400	1220	1100
48/18	4600		
36/26	3400	2020	
48/26	4600		

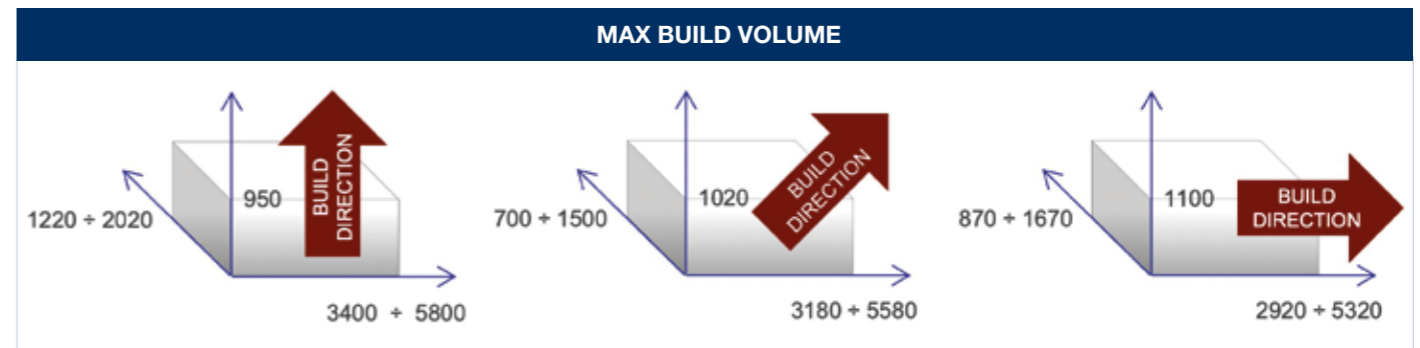

PRECISION AND REPEATABILITY			
LINEAR AXES*	Reference stroke	A	R
X/Y	2000 mm	0.025 mm	0.017 mm
Z	1200 mm	0.021 mm	0.015 mm
B	+/- 120°	26 arcsec	
C	360°	16 arcsec	

* Precision with linear scales and direct encoders on PX5 Accuracy (A) and Repeatability (R) on the basis of the ISO-230-2 Regulations

KREATOR ARES WORKING UNITS AND ELECTROSPINDLES	
	PX5 - 20_24 (sincronous)
NOMINAL POWER (S1)	20 kW
MAX POWER	22,3 kW
MAX RPM	24.000 rpm
MAX TORQUE	20 Nm
TOOL CHANGER	MANUAL AND AUTOMATIC
TOOLHOLDER	HSK 63 A
COOLING	LIQUID

KREATOR ARES: TOOL CHANGER MAGAZINES	
N. STATIONS	20 carousel
HOLDER INTERAXES (MM)	117
Ø MAX WITHOUT LIMITATION (MM)	110
Ø MAX WITH LIMITATION (MM)	250
MAX TOOL LENGTH (MM)	465
MAX WEIGHT SINGLE TOOL	6 kg

CMS connect the IoT platform perfectly integrated with the latest-generation CMS machines

CMS Connect is able to offer customised micro services through the use of IoT Apps that support the daily activities of industry operators - improving the availability and use of machines or systems. The platform displays, analyses and monitors all data from connected machines. The data collected by the machines in real time become useful information increase machine productivity, reduce operating and maintenance costs and cut energy costs.



CMS active a revolutionary interaction with your CMS machine

Cms active is our new interface. The same operator can easily control different machines as the “CMS Active interfaces maintain the same look&feel, icons and iteration approach.



APPLICATIONS

SMART MACHINE: Section designed for the continuous monitoring of machine operation, with information on:

Status: machine status overviews. The representations provided allow machine availability to be checked - to identify possible bottlenecks in the production flow;

Monitoring: instantaneous, live display of the operation of the machine and its components, of currently running programs and potentiometers;

Production: list of machine programs run within a given timeframe with best time and average running time;

Alarms: active and historical warnings.

SMART MAINTENANCE

This section provides a first approach to predictive maintenance by sending notifications when machine components indicate a potentially critical state associated with reaching a certain threshold. In this way, it is possible to take action and schedule maintenance services, without any down-time.

SMART MANAGEMENT

Section designed for KPI presentation for all the machines connected to the platform. The indicators provided assess of the availability, productivity and. The indicators provided assess of the availability,

productivity and efficiency of the machine and the quality of the product.

MAXIMISED SECURITY

CMS Connect uses the standard OPC-UA communication protocol, which guarantees the encryption of data at Edge interface level. CMS Connect's Cloud and DataLake levels meet all state-of-the-art cyber-security requirements. Customer data are encrypted and authenticated to ensure total protection of sensitive information.

ADVANTAGES

- ✓ Optimisation of production performance
- ✓ Diagnostics to support components warranty optimisation
- ✓ Productivity increase and downtime reduction
- ✓ Improvement of quality control
- ✓ Maintenance costs down

EASY OF USE

The new interface has been especially developed and optimized to be immediately used via touch screen. Graphics and icons have been redesigned for user-friendly and comfortable navigation.

ADVANCED ORGANIZATION OF PRODUCTION

Cms Active enables configuring different users with different roles and responsibilities according to the operation mode of the machining centre (e.g.: operator, maintenance man, administrator, ...).

It is also possible to define the work shifts on the machining centre and then survey activities, productivity and events that have occurred in each shift.

ABSOLUTE QUALITY OF THE FINISHED WORKPIECE







With CMS aActive the quality of the finished workpiece is no longer jeopardized by worn-out tools. The new Tool Life Determination system of CMS Active sends warning messages when the tool life is running out and recommends its replacement at the most appropriate time.

TOOL SET-UP? NO PROBLEM!

CMS Active guides the operator during the tool magazine set-up phase, also allowing for the programs to be run.



SERVICE OUR TECHICIANS BY YOUR SIDE ALL OVER THE WORLD

-  Training
-  Installation
-  Remote Customer Care (RCC)
-  On-site assistance
-  Maintenance
-  Changes & Retrofitting
-  Spare Parts

A GLOBAL PRESENCE FOR BEST-IN-CLASS SERVICE

- 36,000 different codes to serve machinery of all ages;
- 1 central warehouse at the headquarters in Zogno and 6 bases around the world fully integrated at IT level and controlled by a shipping optimisation software to reduce waiting times;
- 98% of orders available in stock;
- spare parts guaranteed thanks to a scrupulous control process and validation via our internal quality laboratory;
- availability to draw up recommended spare parts lists based on client needs, to reduce down time to a minimum;

CMS ADVANCED MATERIALS TECHNOLOGY RANGE OF MACHINES

FOR COMPOSITE MATERIALS, ALUMINUM AND METAL PROCESSING

MONOBLOC CNC MACHINING CENTERS FOR VERTICAL MILLING



ARES



ANTARES



ANTARES K



VM 30



ETHOS K

GANTRY CNC MACHINING CENTERS FOR LARGE-SIZE WORK AREAS



MX5



POSEIDON

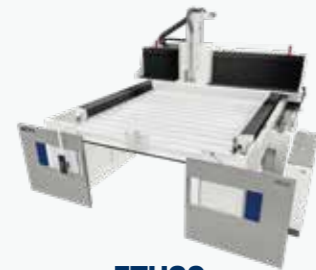

ETHOS



CONCEPT

HYBRID ADDITIVE MANUFACTURING AND MILLING SYSTEMS



KREATOR ARES

MONOBLOC CNC MACHINING CENTERS FOR HORIZONTAL MILLING



IKON

FIXED AND MOBILE BRIDGE CNC MACHINING CENTERS



FXB

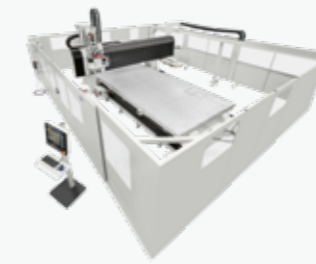

MBB



AVANT

CNC MACHINING CENTER FOR THE EYEWEAR INDUSTRY



MONOFAST



EOS

WIND BLADE WORKING SYSTEMS

CNC MACHINING CENTERS FOR GUNSTOCKS PROCESSING



MULTILATHE



MONOFAST



KARAT

WATERJET CUTTING SYSTEMS



TECNOCUT PROLINE



TECNOCUT SMARTLINE



THE MOST ADVANCED SKILLS AND KNOW-HOW IN THE FIELDS OF MACHINERY AND INDUSTRIAL COMPONENTS

A technological world leader in processing a wide variety of materials: wood, plastic, glass, stone, metal and composites. The Group companies, operating throughout the world, are reliable partners of leading companies in various market sectors, including the furniture, construction, automotive,

aerospace, ship-building and plastic processing industries. SCM Group coordinates, supports and develops a system of industrial excellence in 3 large highly specialized production centres employing more than 4.000 workers and operating in all 5 continents.

INDUSTRIAL MACHINERY

Standalone machines, integrated systems and services dedicated to the processing of a wide range of materials.



Woodworking technologies



Technologies for advanced materials, plastic, stone, glass and metals processing



INDUSTRIAL PARTS

Technological components for Group and third party machines and plants and for the mechanical industry



Electro-spindles and technological components



Electrical panels



Metalworking and mechanical machining



Cast Iron

SCM GROUP IN BRIEF

850
Million/Euro
in consolidated
turnover

+4.000
people
in Italy
and abroad

3 main
production
centres

5 A presence on
continents
that is direct and
widespread

7%
of turnover
invested in R&D



C.M.S. SPA

via A. Locatelli, 123 - 24019 Zogno (BG) - IT

Tel. +39 0345 64111

info@cms.it

cms.it

a company of **scm**group